

Serie DDTS-45

Load capacity Up to 80 kg/pair

Over extension

Cross section 26,0 x 40,0 mm

Material

Steel (C45E+C)
galvanised
milled airway

DDTS-...

one-way extension

DDTS-45

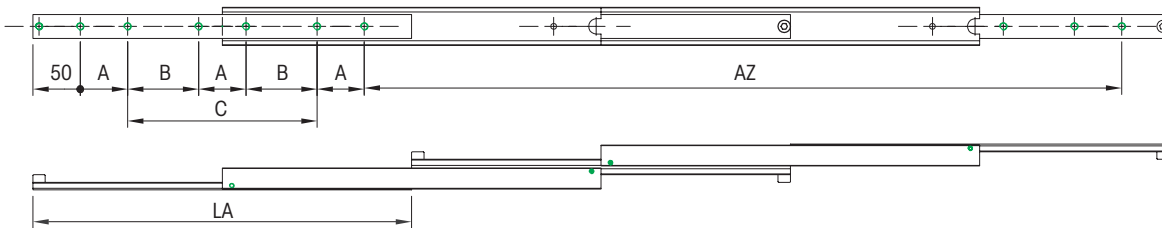

Info:

L = Length
TP = Travel path
LC = Load capacity at
10,000 cycles
● Drill pattern

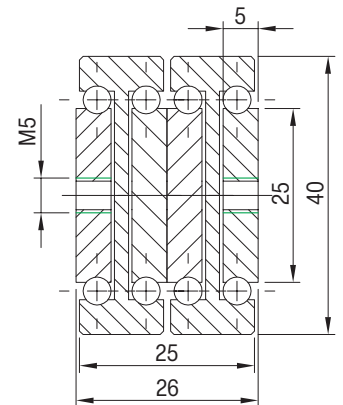

Article-Nr. DDTS-45	LC in kg 10.000	L mm	TP mm	A mm	B mm	C mm	Weight - kg/piece. DDTS-45
07000476001	60	150	300	50	-	-	0,98
07000476002	65	200	400	50	-	-	1,30
07000476003	70	250	500	50	-	50	1,63
07000476004	75	300	600	50	-	100	1,95
07000476005	80	350	700	50	-	150	2,28
07000476006	75	400	800	50	-	200	2,60
07000476007	70	450	900	50	-	250	2,93
07000476008	65	500	1000	50	-	300	3,25
07000476009	60	550	1100	50	150	-	3,58
07000476010	55	600	1200	50	175	-	3,90
07000476011	50	650	1300	50	200	-	4,23
07000476012	45	700	1400	50	225	-	4,55
07000476013	40	750	1500	50	250	-	4,88
07000476014	35	800	1600	50	275	-	5,20
07000476015	30	850	1700	50	300	-	5,53
07000476016	25	900	1800	50	325	-	5,85
07000476017	20	950	1900	50	350	-	6,18
07000476018	15	1000	2000	50	375	-	6,50